

Article number: 4395001201

Description: Rota-fix shaft-hub connection F120x165
Stainless steel

Measures

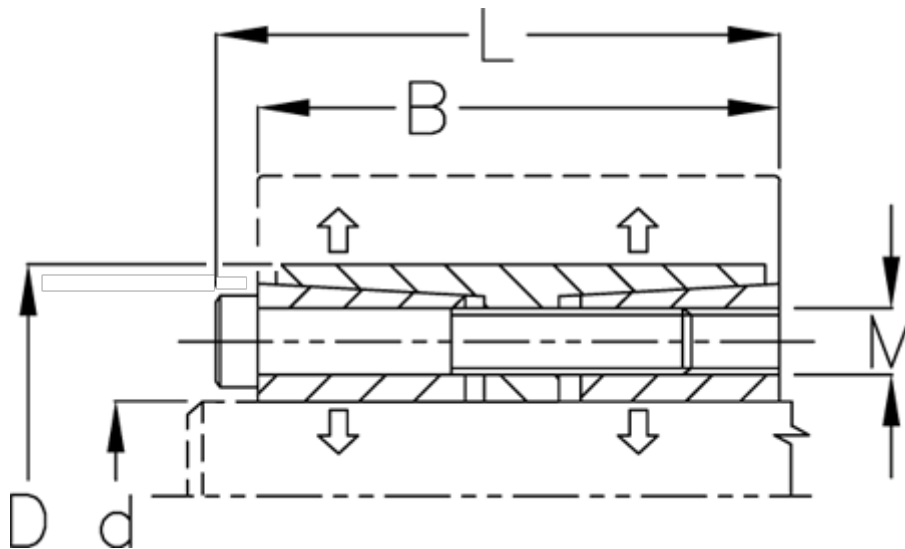

B mm	= 102
d H8 mm	= 120
D mm	= 165
Fit tolerance	= Aksel h8, Nav H8
F kN torque	= 368.0
L mm	= 114
M mm	= M12
P N/mm ² surface pressure on shaft/hub	= 41

Surface roughness	= R? ? 3.2 μ m
T N m torque	= 22100
Ts N m bolt tightening torque	= 100.0